

Attika  
5.OG  
4.OG  
3.OG  
2.OG  
1.OG

**Wohnung Nr. 207**

Anzahl Zimmer: 4.5 Zi  
Etage: 2. OG  
Nettowoohnfläche: 101 m<sup>2</sup>  
Aussenraum: 19.2 m<sup>2</sup>

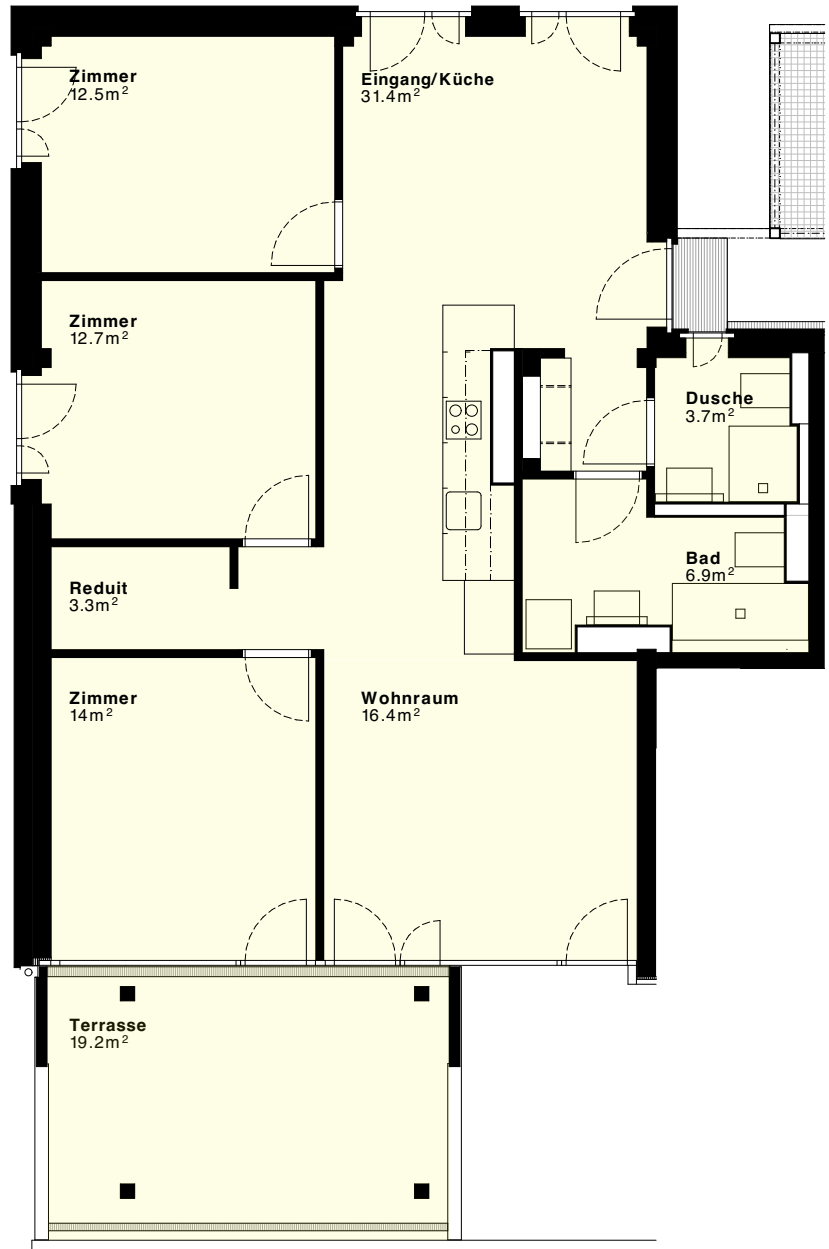

0 1 2 3 4 5m



Baugenossenschaft  
Dietikon

**Kontakt Vermietung**

Die Schächli Baugenossenschaft Dietikon  
Schöneggstrasse 29  
8953 Dietikon  
044 741 46 84  
info@dieschaechli.ch

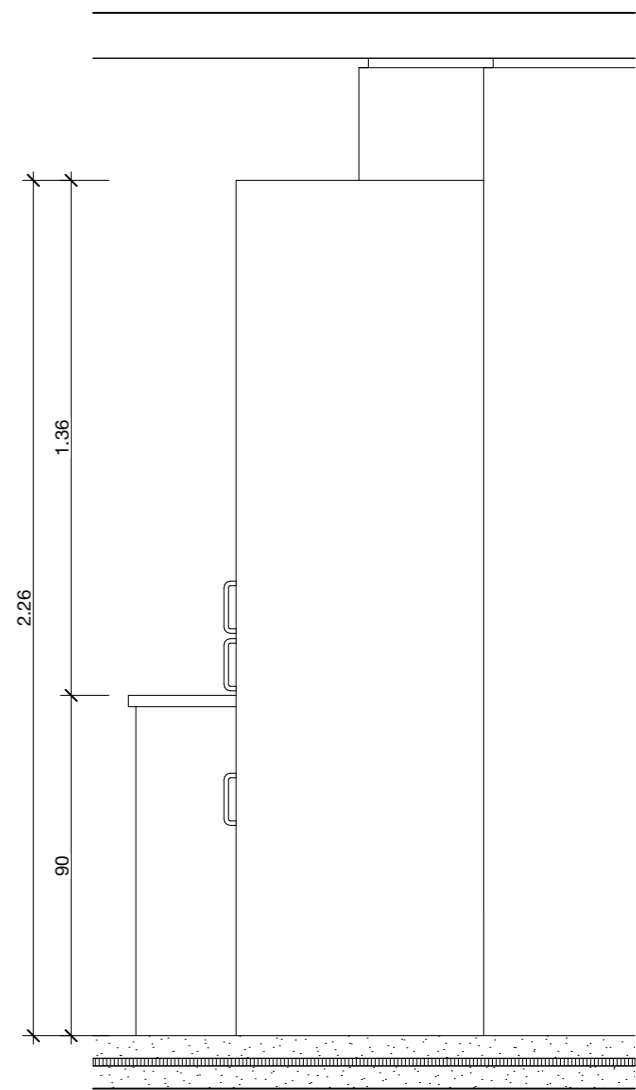
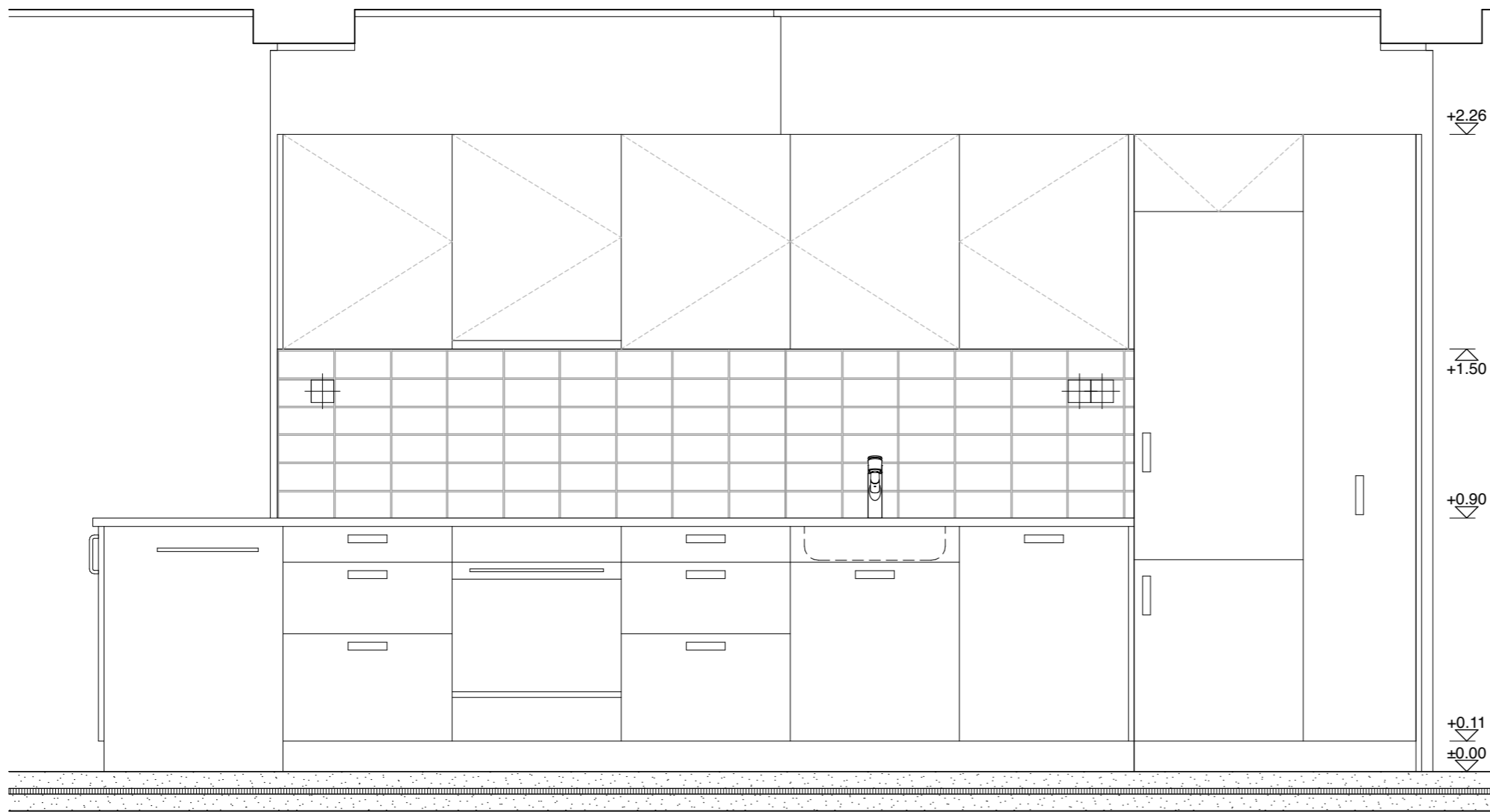

Ansicht A

Ansicht B

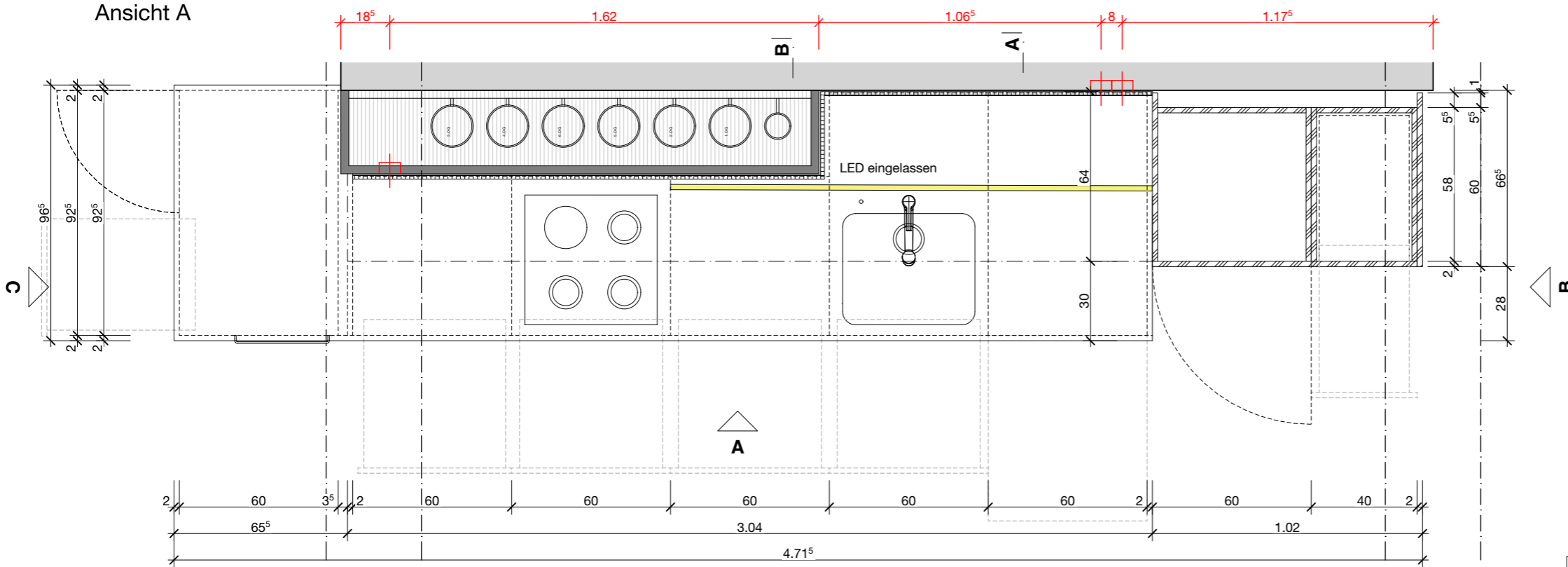

Unterbau  
2 Tablare  
  
Auszüge

Auszüge  
  
Oberschrank

Backofen / Kochfeld  
  
Umlufthaube

Auszüge  
  
Oberschrank

Spülbecken  
Müllsystem  
  
Oberschrank  
Übertiefe 60

Spülmaschine  
  
Oberschrank  
Übertiefe 60

Kühlschrank  
Tiefkühler  
  
Schrank nach  
oben öffnend

Hochschrank  
Auszug mit  
Übertiefe 65

<b>Neubau Wohnhaus Entenbad – 8953 Dietikon</b>							
Ausführung							
Küchen							
<b>Typ K.1-5_07_1</b>							
Datum:	11.10.23	Index:	B	Format:	A3	Gez.:	div.
Masstab:	1:20	Plan Nr.:	AF-DET_506.12.1				

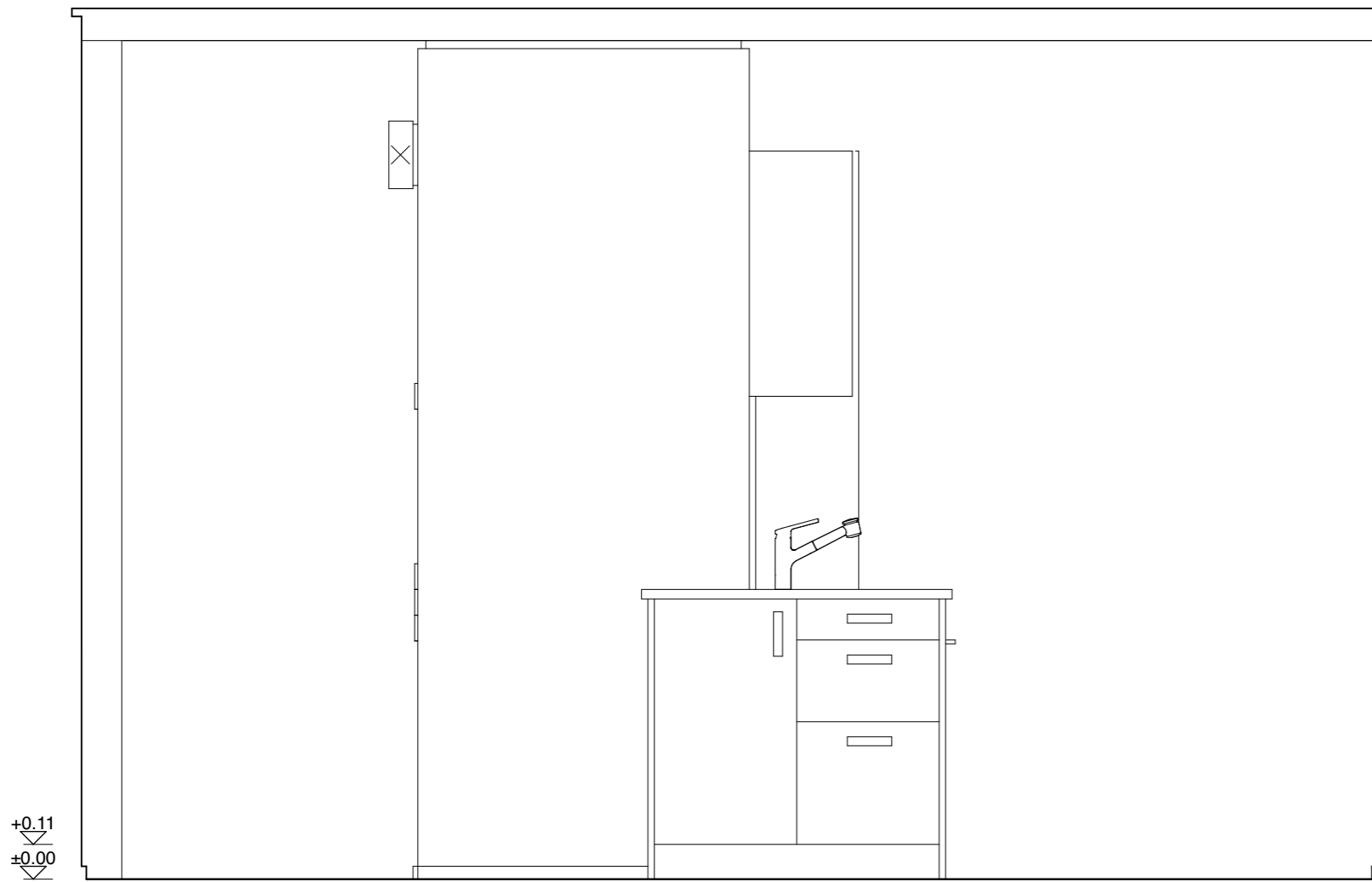

Ansicht C-C

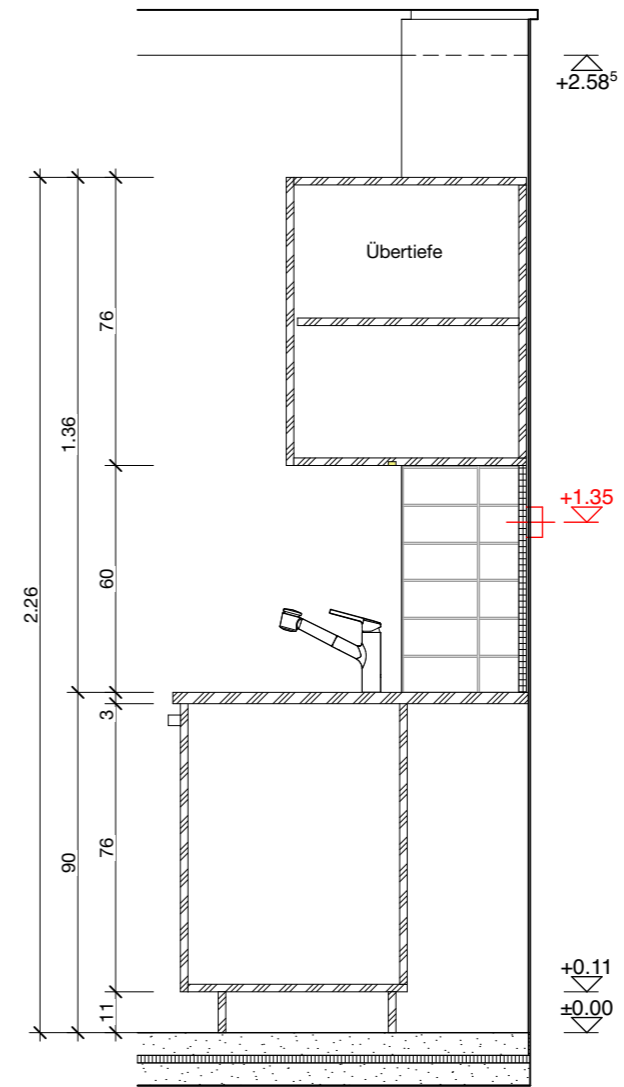

Schnitt A-A

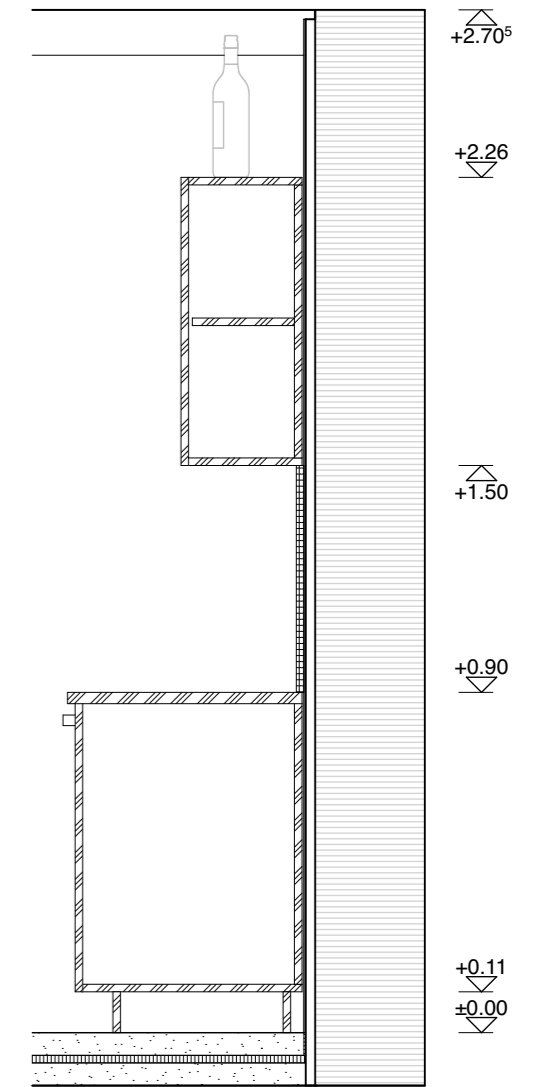

Schnitt B-B